











 $\varnothing 6,3 \times 50 \text{ mm}$ A1 x 34	 $\varnothing 12 \text{ mm}$ A2 x 34	 4 mm A3 x 1	 $\varnothing 15 \times 12 \text{ mm}$ B1 x 30	 $\varnothing 5 \times 44 \text{ mm}$ B2 x 30
 $\varnothing 20 \text{ mm}$ B3 x 30	 $\varnothing 4 \times 16 \text{ mm}$ D1 x 19	 $\varnothing 4 \times 30 \text{ mm}$ D2 x 2	 $\varnothing 1,6 \times 25 \text{ mm}$ F x 54	 $\varnothing 8 \times 36 \text{ mm}$ G x 54
 H x 1	 M x 4	 $\varnothing 15 \text{ mm}$ N1 x 4	 N2 x 1	



Box 1 / 3





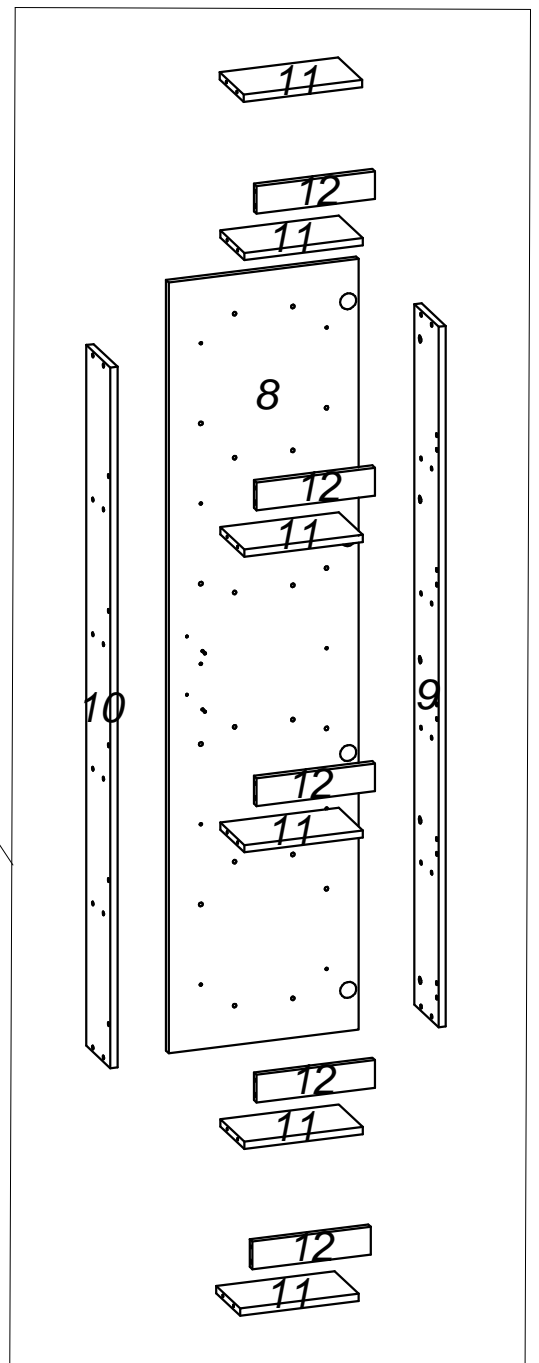
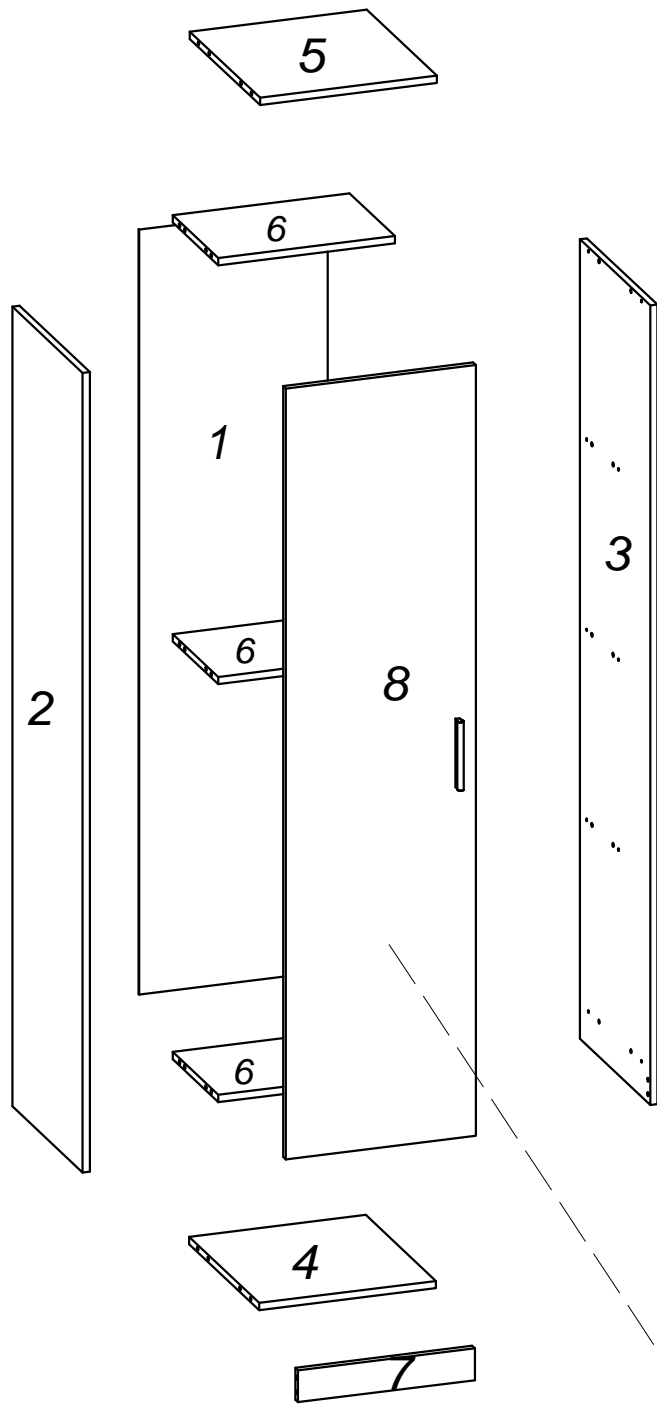
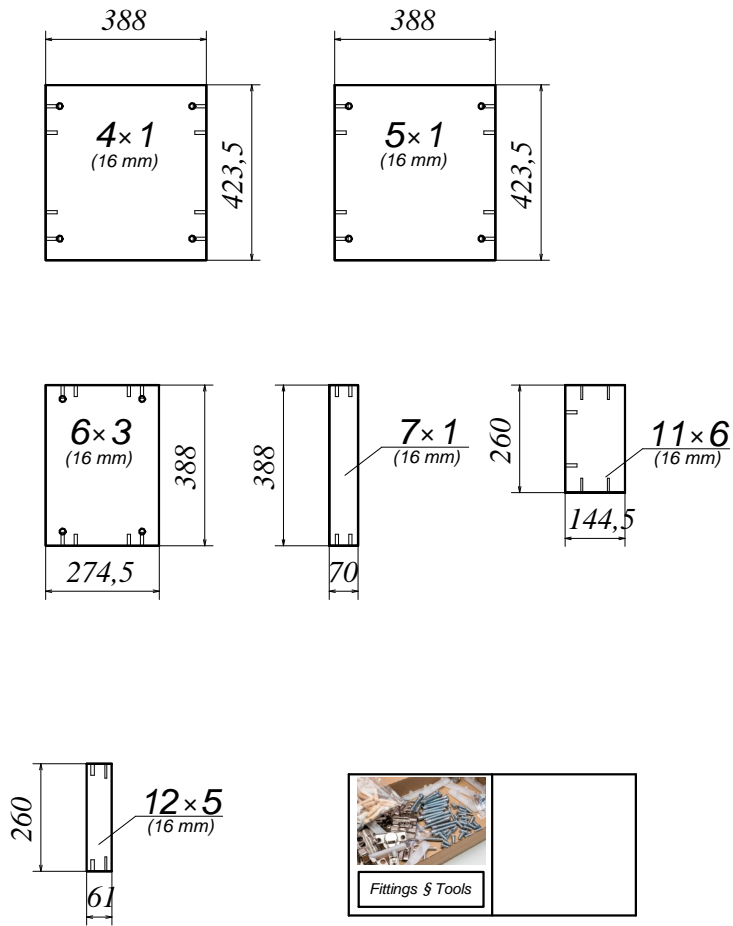
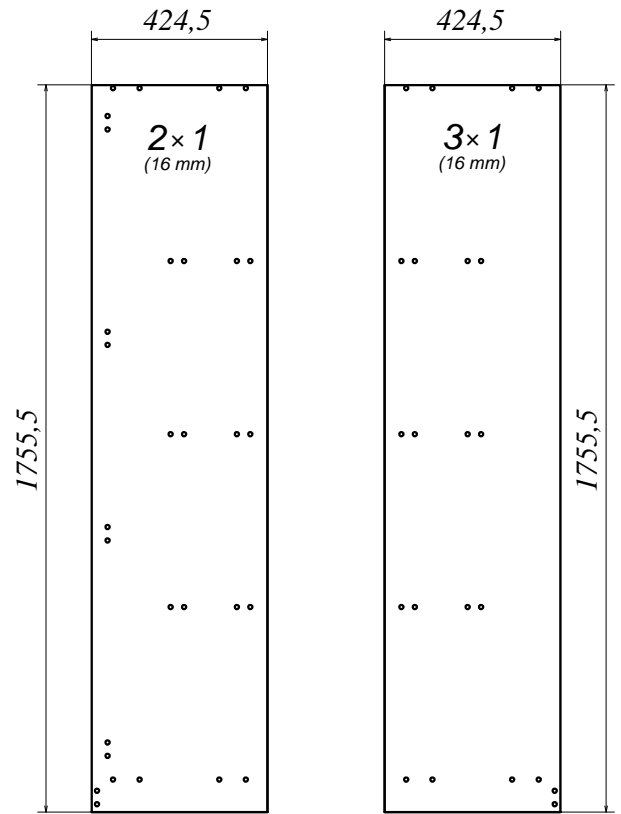

Box 2 / 3

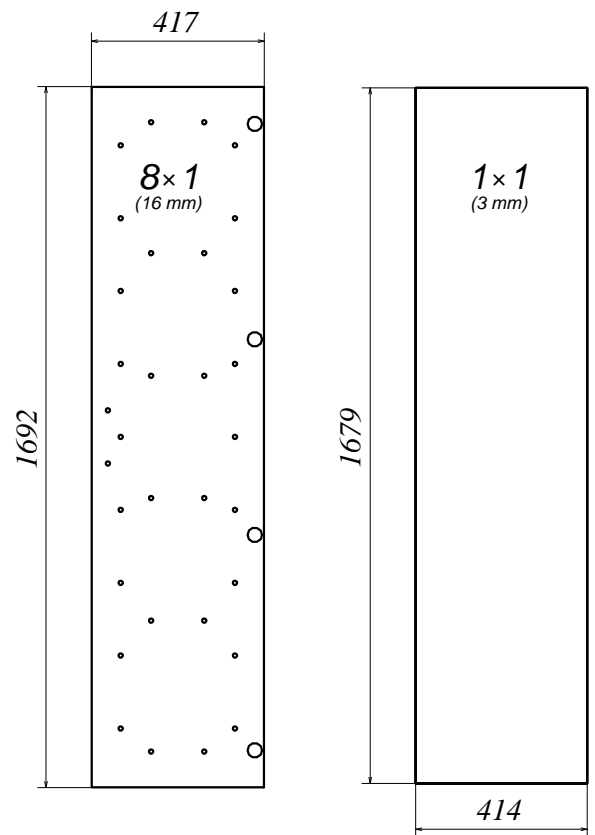
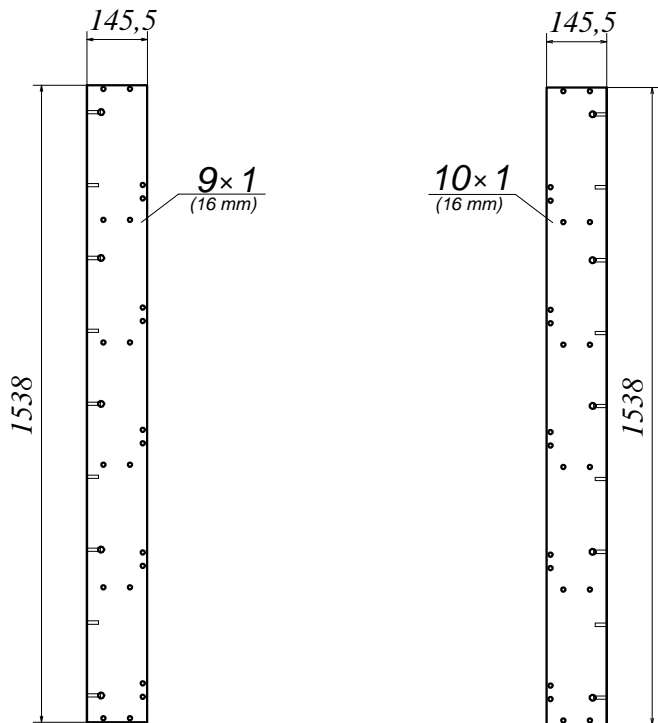

Box 3 / 3



1

 Ø15x12 mm B1 x 20	 Ø5x44 mm B2 x 20	 Ø4x16 mm D1 x 8	 Ø8x36 mm G x 24	 M x 4				
--	---	--	--	---	--	--	--	--

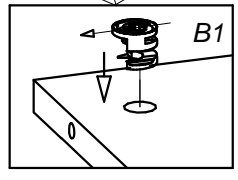
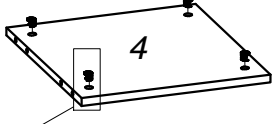
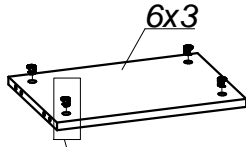
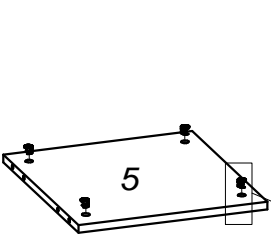
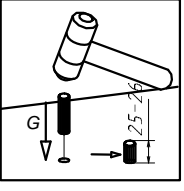
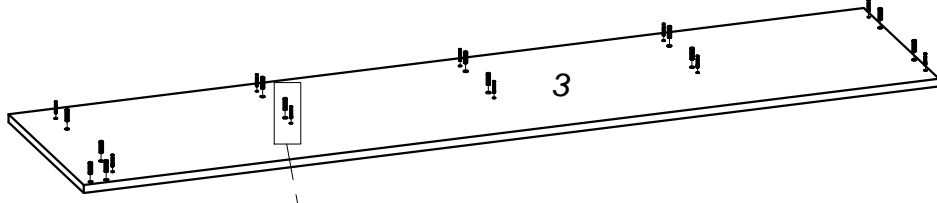
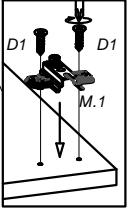
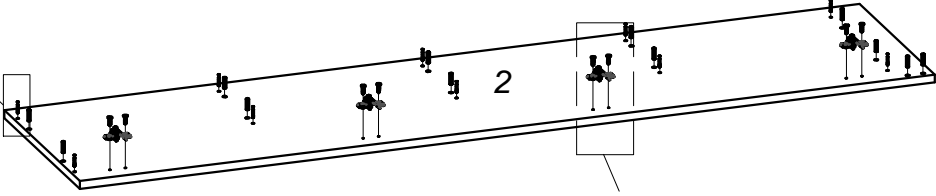
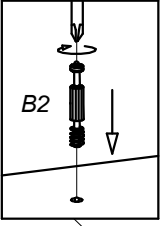

2

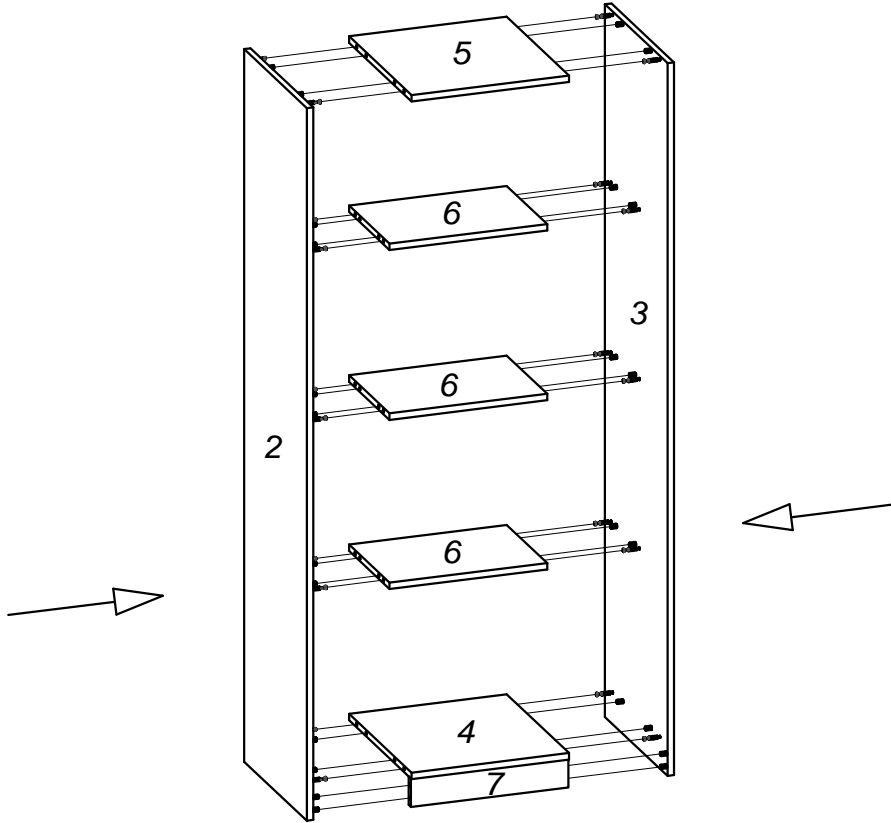
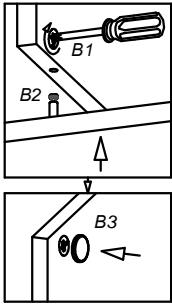
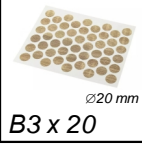

3

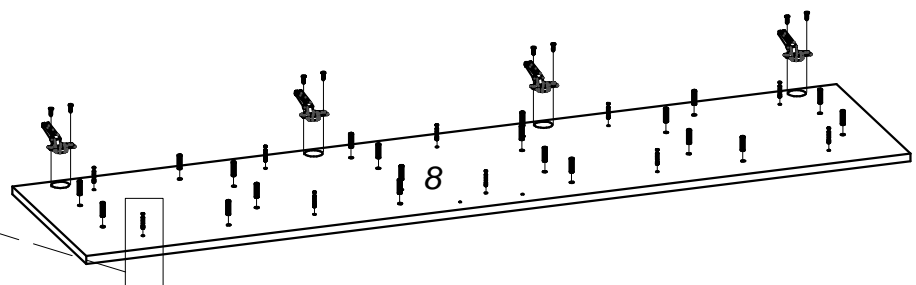
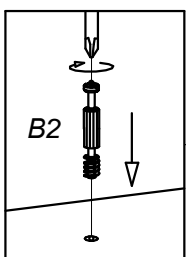
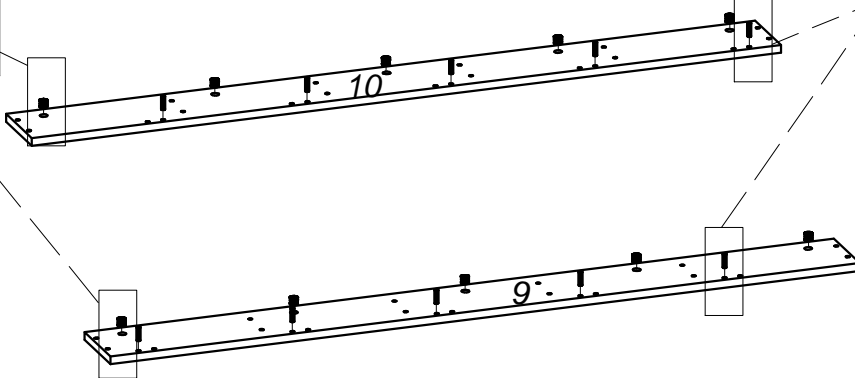
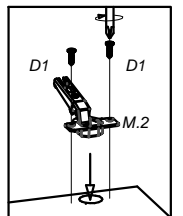
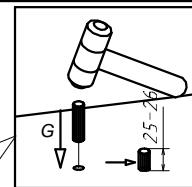
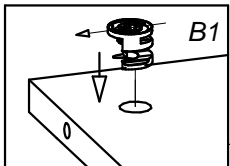
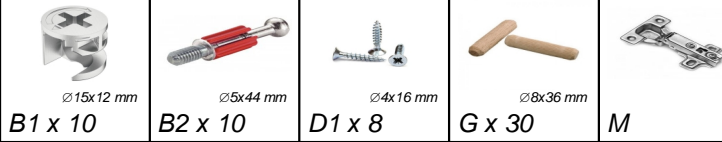

4

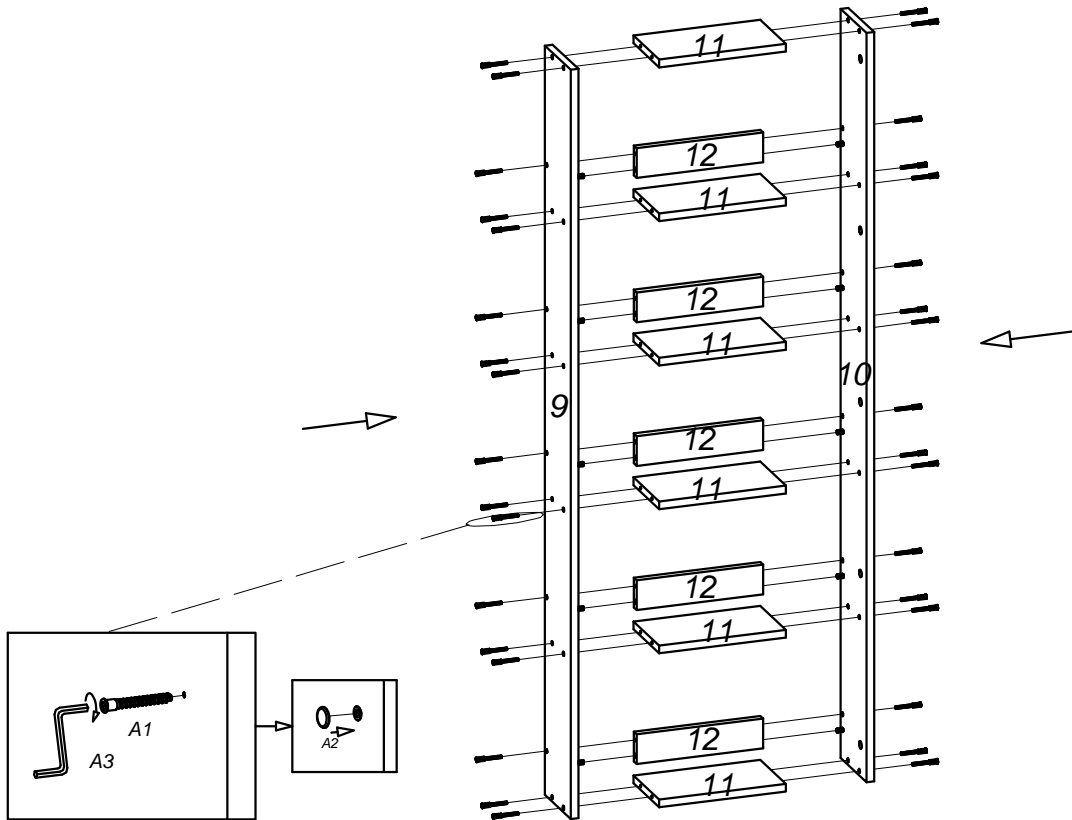
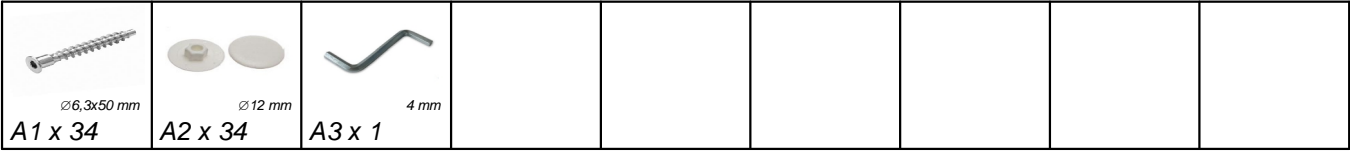

5

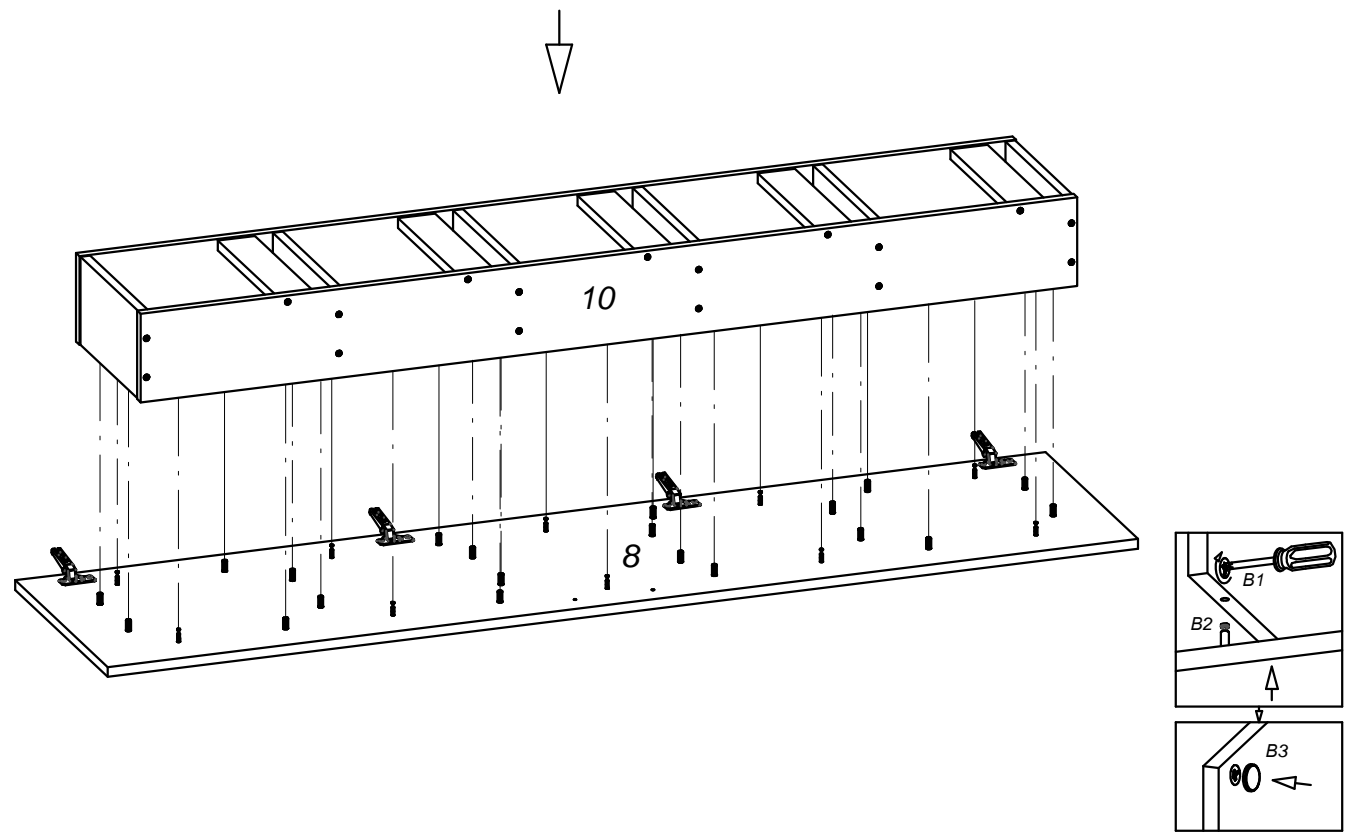

6

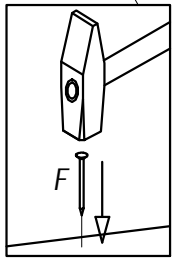
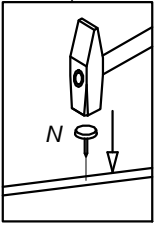
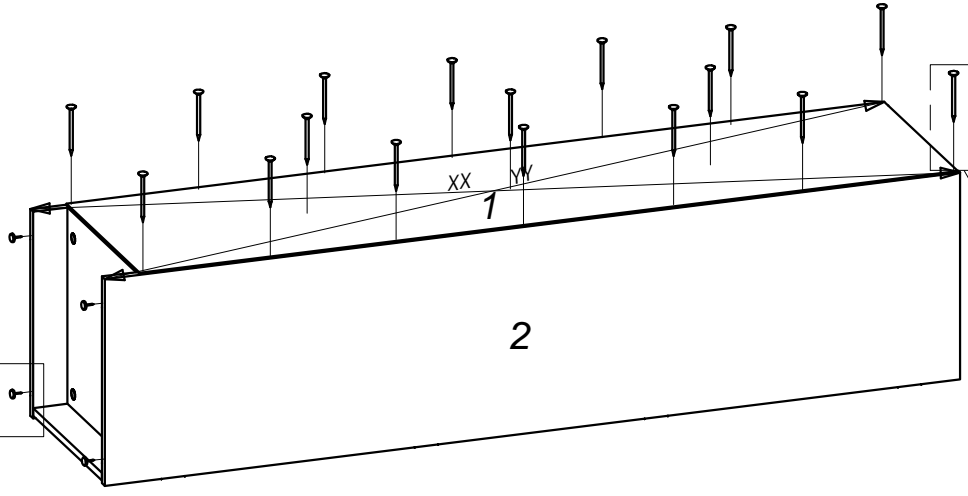

7

